

## Notes:

1. Terminal Material: Aluminum & Copper
2. Wire Size: 1 AWG (50mm<sup>2</sup>)
3. Stud Size: 1/2" Stud
4. Operating Temperature: -40°C to 100°C

### Standard (Metric)

A: 2.95" (75mm)  
 B: 1.3" (32mm)  
 D: 0.37" (9.5mm)  
 E: 0.94" (24mm)  
 G: 1.02" (26mm)  
 H: 0.18" (4.5mm)

### Tolerances

(Unless Otherwise Specified)

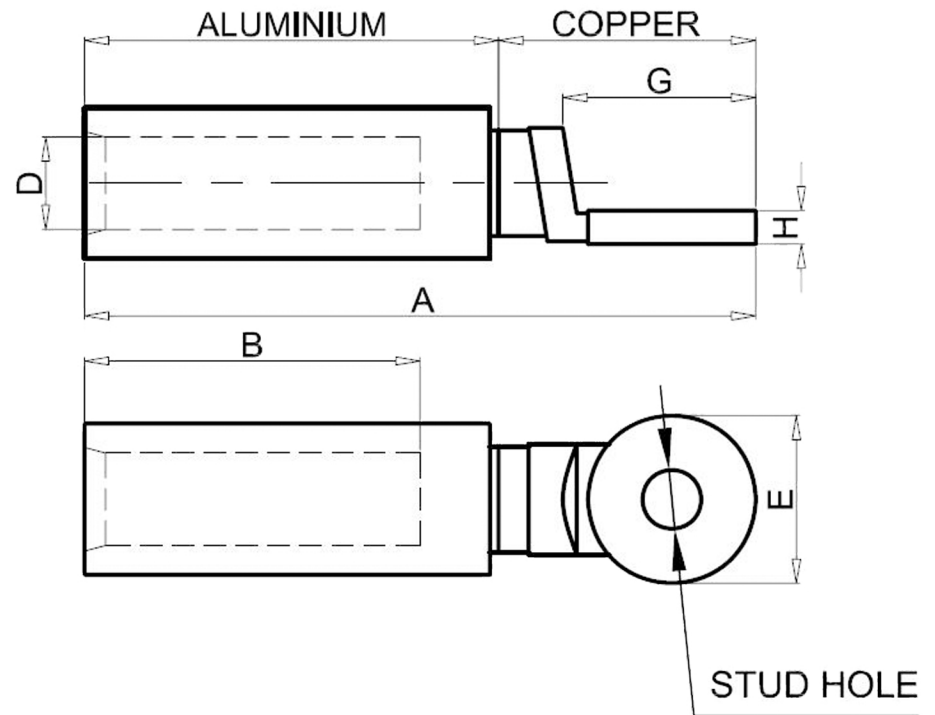

CATEGORY

Bimetallic  
Compression Lugs

SCALE

4/1

PART #

BML50-12

SHEET

1-3

MATERIAL

Aluminum & Copper

PAGE

10F2



**MIROMAR**