

Notes:

1. Terminal Material: Aluminum & Copper
2. Wire Size: 4 AWG (25mm²)
3. Stud Size: 1/2" Stud
4. Operating Temperature: -40°C to 100°C

Standard (Metric)

A: 2.95" (75mm)
 B: 1.3" (32mm)
 D: 0.30" (7.5mm)
 E: 0.79" (20mm)
 G: 0.94" (24mm)
 H: 0.18" (4.5mm)

Tolerances

(Unless Otherwise Specified)

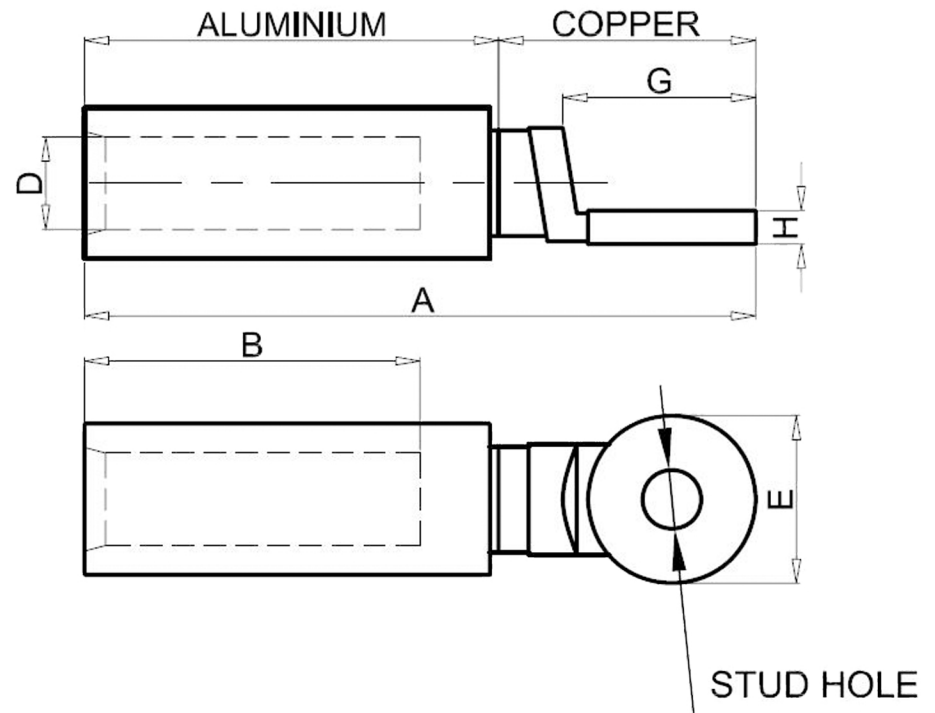

CATEGORY

Bimetallic
Compression Lugs

SCALE

4/1

PART #

BML25-12

SHEET

1-3

MATERIAL

Aluminum & Copper

PAGE

10F2



MIROMAR