

Notes:

1. Terminal Material: Aluminum & Copper
2. Wire Size: 350 MCM (185mm²)
3. Stud Size: 3/8" Stud
4. Operating Temperature: -40°C to 100°C

Standard (Metric)

A: 4.72" (120mm)
 B: 2.4" (60mm)
 D: 0.73" (18.5mm)
 E: 1.4" (35mm)
 G: 1.5" (38mm)
 H: 0.28" (7mm)

Tolerances

(Unless Otherwise Specified)

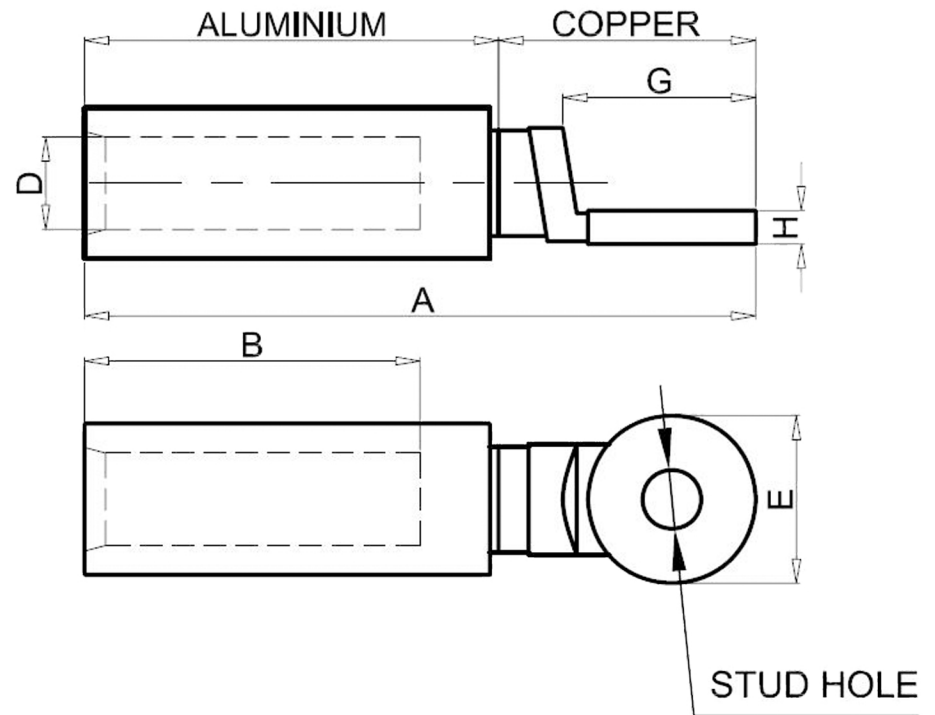

CATEGORY

Bimetallic
Compression Lugs

SCALE

4/1

PART #

BML185-10

SHEET

1-3

MATERIAL

Aluminum & Copper

PAGE

10F2



MIROMAR